



>>The **LEXELL** street lights are the combination of world patent leading street light technology and design to ensure the constant reliability of the products 24 hours a day, 365 days a year.

Design to various industry or country specific standards, our products are designed both OEM and retrofit applications.

Performance Specifications

Lighting Type	Street Light	Street Light
Model	MA-DE80A	MA-DS96A
Wattage	120 Watts	150 Watts
AC Input	AC80~240V	AC80~240V
CRI	>75	>75
Color Temperature	2800 ~ 6000K	2800K ~ 6000K
Lumen	≥ 9792 lm	≥ 12240 lm
Efficacy	≥ 72L/W	≥82 L/W
Power Factor	>0.90	>0.90
Water Resistant	IP 65	IP 65
Rated Life	50,000 Hours	50,000 Hours
Working Temperature	-20°C to + 60°C	-20°C to + 60°C
Housing	Aluminum Die-Case & Sheet Metal	Aluminum Die-Case & Sheet Metal
Weight	10 kgs	10 kgs
Warranty	5 Years	5 Years

Certifications (Driver)   IP67   IP67

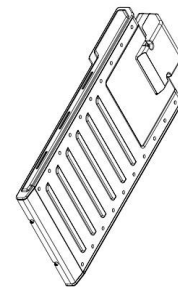
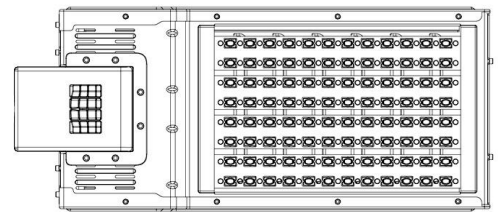
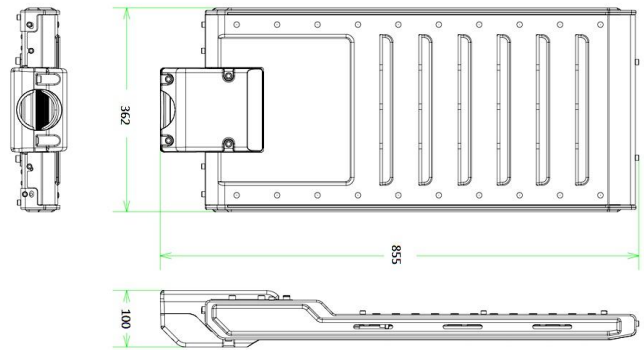

DISTRIBUTION & ROAD SURFACE ISOLUX DIAGRAM

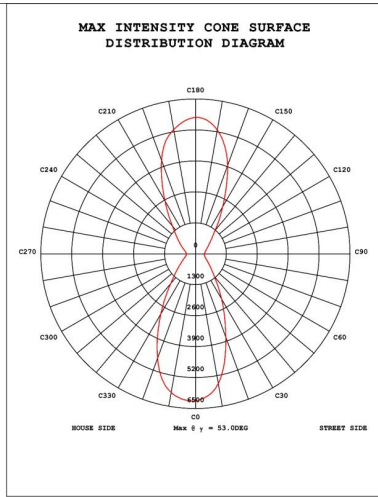
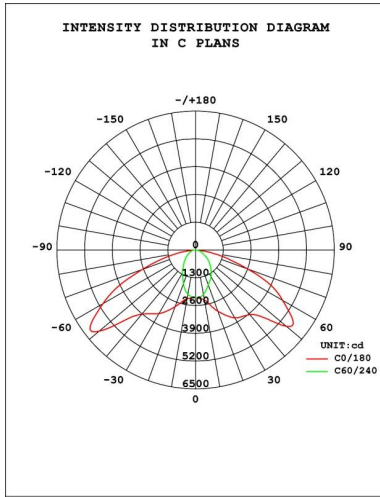

150 WATTS

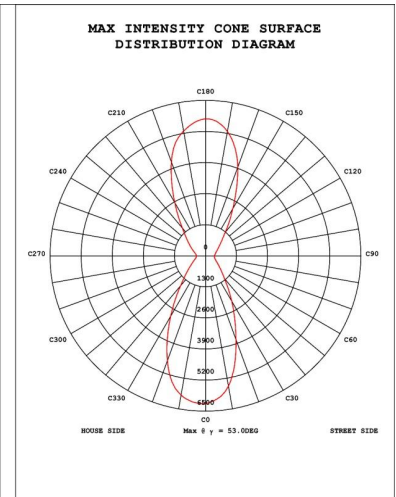
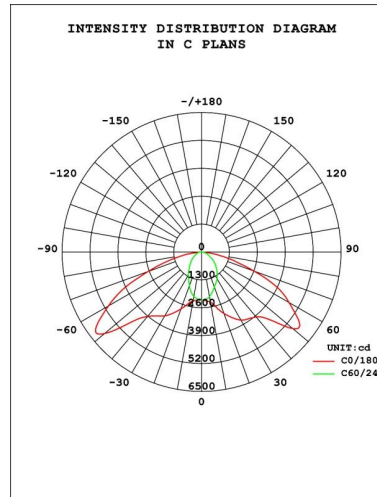

120 WATTS

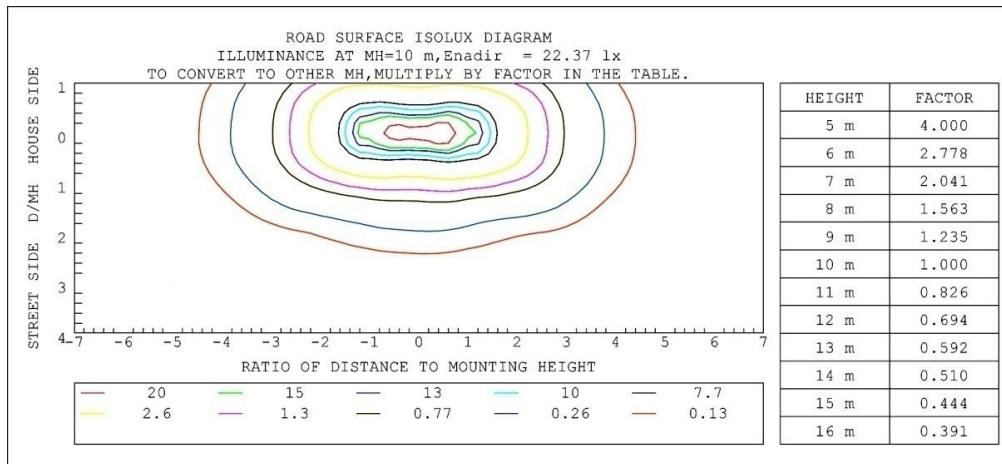

150 WATTS

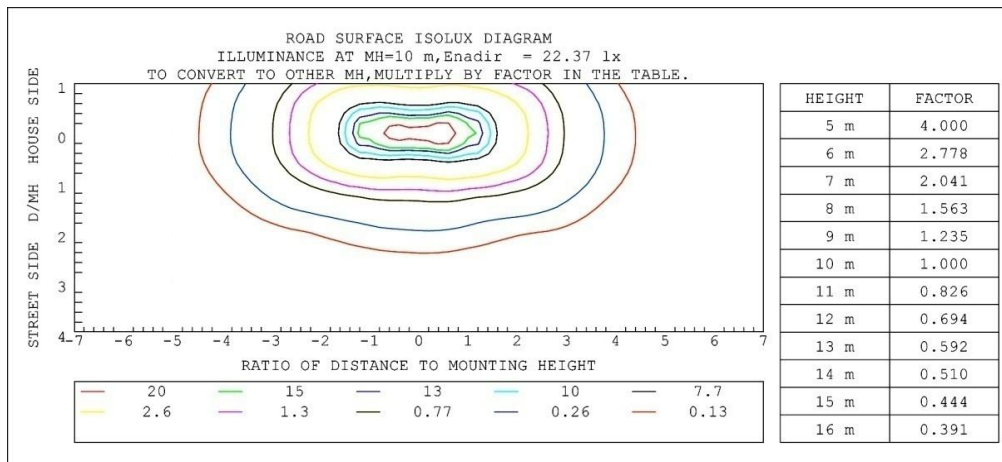

120 WATTS